

Data Sheet



Article number: 204040M1028A0X

Description: E+G levelling foot

GN 40-40-M10-28-A0-X

Note: X With female thread, External hexagon

Measures

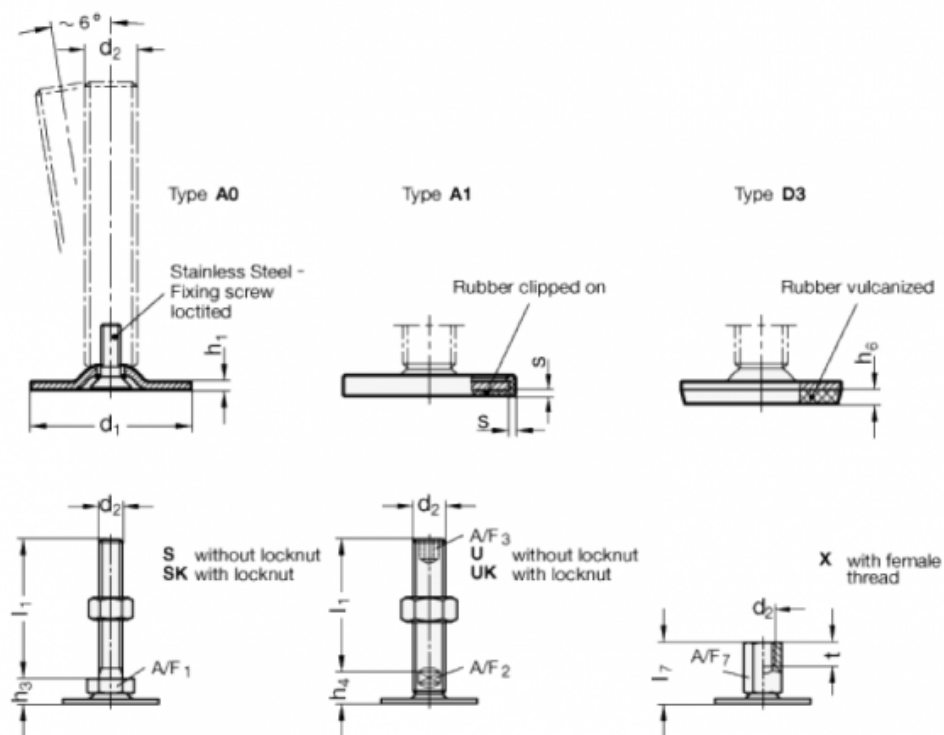

A/F7	=	14
d1	=	40
d2	=	M10
h1	=	2
h6	=	
l7	=	28
s	=	
t	=	10